

63.17 Vaijeriliitin tupla
ZACISK
PODW.

SEND THE INQUIRY
 +358 103 195 100

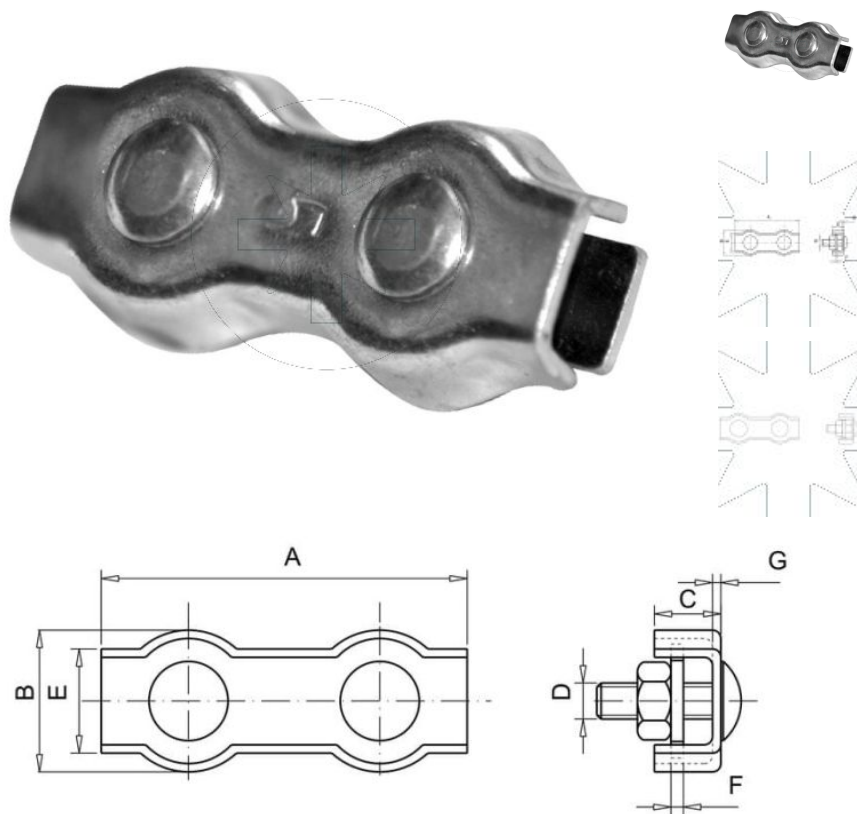

Pinnoite tyyppi:

B
 POWŁOKA
 CYNKOWA
 BIAŁA

Dimensions

Material index	Tyyppi	A [mm]	B [mm]	C [mm]	D [mm]	E [mm]	f [mm]	G [mm]
6317008S	8	76	30	14	8	22	2	2
6317006S	6	63	23	10	6	17	1.5	1.5
6317002S	2	30	15	6.5	4	10	1.5	1.5
6317005S	5	51	20	8.5	5	14	1.5	1.5
6317003S	3	38	18	7.5	5	12	1.5	1.5