

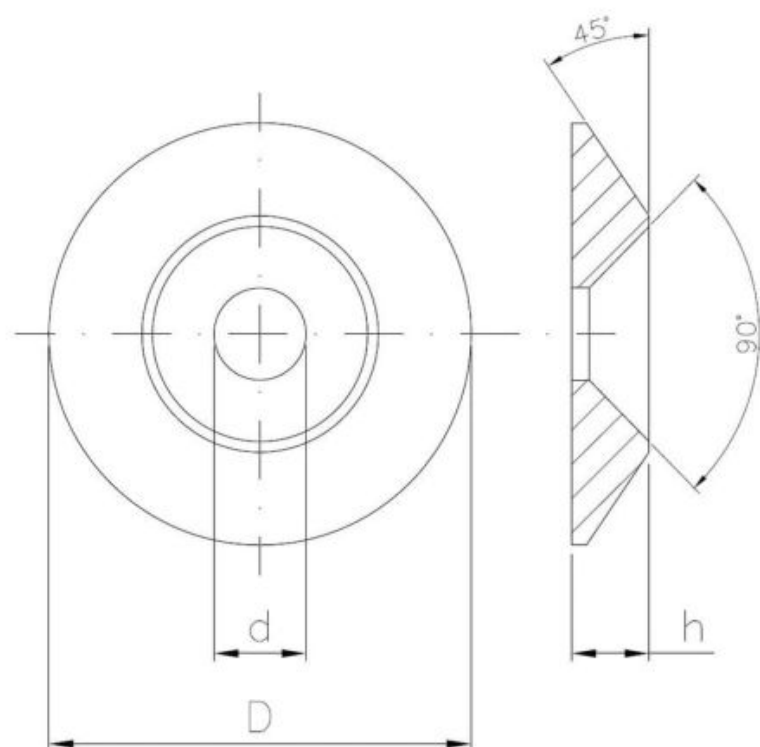

Pinnoite tyyppi:



SEND THE INQUIRY
+358 103 195 100



Dimensions

Material index	d [mm]	D [mm]	h [mm]	Pinnoite tyyppi
1431100300AT	10.5	30.0	6.6	A - powłoka cynkowa w pasywacji żółtej
1431080245AT	8.5	24.5	5.4	A - powłoka cynkowa w pasywacji żółtej
1431060195AT	7.5	19.5	4.6	A - powłoka cynkowa w pasywacji żółtej